

Optimum Protection when collecting Liquid Waste.

In the hectic daily routine of a laboratory, things can easily go wrong. Open containers become a danger to people and the environment. Anyone who wants to get their waste disposal under control therefore needs a coherent concept.

Алматы (727)345-47-04
Ангарск (3955)60-70-56
Архангельск (8182)63-90-72
Астрахань (8512)99-46-04
Барнаул (3852)73-04-60
Белгород (4722)40-23-64
Благовещенск (4162)22-76-07
Брянск (4832)59-03-52
Владивосток (423)249-28-31
Владикавказ (8672)28-90-48
Владимир (4922)49-43-18
Волгоград (844)278-03-48
Вологда (8172)26-41-59
Воронеж (473)204-51-73
Екатеринбург (343)384-55-89

Иваново (4932)77-34-06
Ижевск (3412)26-03-58
Иркутск (395)279-98-46
Казань (843)206-01-48
Калининград (4012)72-03-81
Калуга (4842)92-23-67
Кемерово (3842)65-04-62
Киров (8332)68-02-04
Коломна (4966)23-41-49
Кострома (4942)77-07-48
Краснодар (861)203-40-90
Красноярск (391)204-63-61
Курск (4712)77-13-04
Курган (3522)50-90-47
Липецк (4742)52-20-81

Магнитогорск (3519)55-03-13
Москва (495)268-04-70
Мурманск (8152)59-64-93
Набережные Челны (8552)20-53-41
Нижний Новгород (831)429-08-12
Новокузнецк (3843)20-46-81
Ноябрьск (3496)41-32-12
Новосибирск (383)227-86-73
Омск (3812)21-46-40
Орел (4862)44-53-42
Оренбург (3532)37-68-04
Пенза (8412)22-31-16
Петрозаводск (8142)55-98-37
Псков (8112)59-10-37
Пермь (342)205-81-47

Ростов-на-Дону (863)308-18-15
Рязань (4912)46-61-64
Самара (846)206-03-16
Санкт-Петербург (812)309-46-40
Саратов (845)249-38-78
Севастополь (8692)22-31-93
Саранск (8342)22-96-24
Симферополь (3652)67-13-56
Смоленск (4812)29-41-54
Сочи (862)225-72-31
Ставрополь (8652)20-65-13
Сургут (3462)77-98-35
Сыктывкар (8212)25-95-17
Тамбов (4752)50-40-97
Тверь (4822)63-31-35

Тольятти (8482)63-91-07
Томск (3822)98-41-53
Тула (4872)33-79-87
Тюмень (3452)66-21-18
Ульяновск (8422)24-23-59
Улан-Удэ (3012)59-97-51
Уфа (347)229-48-12
Хабаровск (4212)92-98-04
Чебоксары (8352)28-53-07
Челябинск (351)202-03-61
Череповец (8202)49-02-64
Чита (3022)38-34-83
Якутск (4112)23-90-97
Ярославль (4852)69-52-93

Россия +7(495)268-04-70

Казахстан +7(727)345-47-04

Беларусь +3(727)257-127-884

Узбекистан +998(71)205-18-59

Киргизия +996(312)96-26-47

<https://scat.nt-rt.ru/> || sqt@nt-rt.ru

Safety Funnels

- ✓ Collect Liquid Waste Safely
- ✓ High-Quality Materials
- ✓ Robust and Durable
- ✓ Suitable for Organic Solvents



Harmful Liquids Ever Spilled?

Open containers quickly create fire and health hazards. SCAT safety funnels can be safely closed and prevent ignition hazards. Also available in electrostatic conductive plastic!



You know This? Comparison



Canister without funnel. The contents steam out and are not protected against overflowing. Spills are inevitable.



Double safety due to hinged lid and ball-valve.



MARCO Safety Funnel with Hinged Lid

Smart protection when collecting liquid waste!



Safety Funnel MARCO Technical Details

Safe Closure

- Comfortable handling: easy, quick opening and closing with "click"-closure

Hinged Lid with Sealing Ring

- For secure closure, when the funnel is not in use

Stable Hinge

- A double-screw hinge, constructed of rust-free stainless steel: for long life and stability

Dirt Sieve

- For collecting mixing magnets or large dirt particles. Laboratory bottles can also be placed here to dry off. The hole size has been optimized, in order to improve the running-off of chemicals. **Both sieve and splash protection can be removed for cleaning.**

140 mm

Too coarse-meshed?

- Optionally available: Fine-mesh stainless steel sieve

Various Screw-Threads

- Suitable for different sizes of collecting canister

Safety Lance

- Ensures for safe and good flowing of sensitive chemicals, without any "stuttering"

Dimensions:

- Height with lance: 345 mm
- Height without lance: 125 mm
- Max. width: 185 mm
- Inner diameter: \varnothing 140 mm
- Installation height: + 105 mm, with vertically opened lid: + 270 mm



Safety Funnel MARCO Ordering Information

A 318 952



B 318 992



F 318 999

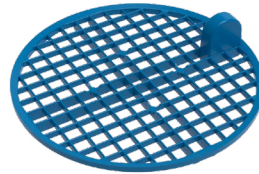

G 318 998



H 319 000



Too coarse-meshed?

- Optionally available: Fine-mesh stainless steel sieve

C 318 960



D 318 980



I 318 989

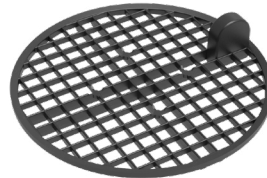

J 318 988



E 317 637

Level Control

- Protection against overflow. Indicates in time when the critical level of the container has reached.

Floater

- Available in 150 mm and 190 mm length

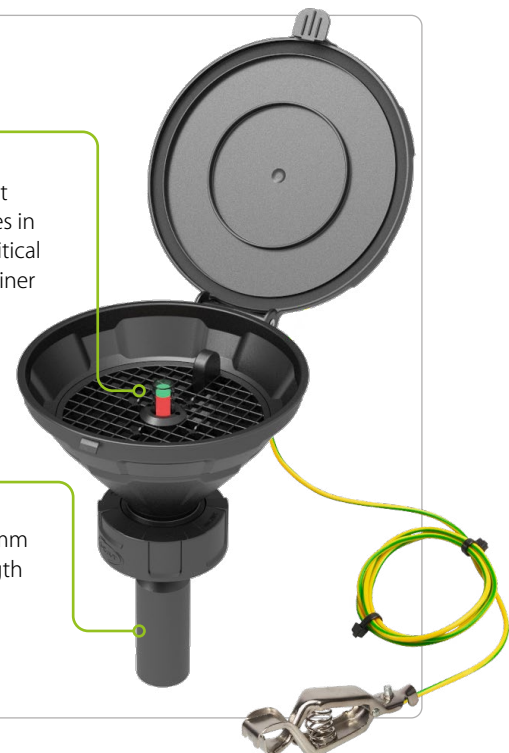

Might interest you

When our lid funnel MARCO is combined with the LISA, this combination goes by the name of JAN, see **page 94**.



Safety Funnel MARCO

Ordering Information



Informations about "delivery with adapter":

The safety funnel MARCO is available in various container screw-thread sizes. In order that we may produce in an environmentally-friendly and economic manner, certain variants are delivered together with a screw-thread adapter. Those to which this applies can be seen in the column "Delivery with Adapter".

Fig.	Part No.	Description	Screw-Thread of Container	Lance (220 mm)	Electrostatic conductive	Material	Level Control	Delivery with Adapter
A	318 952	Hinged lid Funnel MARCO	GL 45	-	-	PE-HD	-	-
	318 962	Hinged lid Funnel MARCO	GL 45	-	●	PE-HD-EL	-	-
B	318 992	Hinged lid Funnel MARCO	GL 45	●	-	PE-HD	-	-
	318 955	Hinged lid Funnel MARCO	S 50	-	-	PE-HD	-	●
	318 985	Hinged lid Funnel MARCO	S 50	●	●	PE-HD-EL	-	●
	318 995	Hinged lid Funnel MARCO	S 50	●	-	PE-HD	-	●
	318 953	Hinged lid Funnel MARCO	S 51	-	-	PE-HD	-	●
	318 983	Hinged lid Funnel MARCO	S 51	●	●	PE-HD-EL	-	●
	318 993	Hinged lid Funnel MARCO	S 51	●	-	PE-HD	-	●
	318 951	Hinged lid Funnel MARCO	S 55	-	-	PE-HD	-	-
	318 961	Hinged lid Funnel MARCO	S 55	-	●	PE-HD-EL	-	-
	318 981	Hinged lid Funnel MARCO	S 55	●	●	PE-HD-EL	-	-
	318 991	Hinged lid Funnel MARCO	S 55	●	-	PE-HD	-	-
	318 950	Hinged lid Funnel MARCO	S 60/61	-	-	PE-HD	-	-
C	318 960	Hinged lid Funnel MARCO	S 60/61	-	●	PE-HD-EL	-	-
D	318 980	Hinged lid Funnel MARCO	S 60/61	●	●	PE-HD-EL	-	-
	318 990	Hinged lid Funnel MARCO	S 60/61	●	-	PE-HD	-	-
E	317 637	Hinged lid Funnel MARCO	S 60/61	-	●	PE-HD-EL	● 150 mm	-
	317 651	Hinged lid Funnel MARCO	S 60/61	-	●	PE-HD-EL	● 190 mm	-
	318 954	Hinged lid Funnel MARCO	S 65	-	-	PE-HD	-	●
	318 964	Hinged lid Funnel MARCO	S 65	-	●	PE-HD-EL	-	●
	318 984	Hinged lid Funnel MARCO	S 65	●	●	PE-HD-EL	-	●
K	318 994	Hinged lid Funnel MARCO	S 65	●	-	PE-HD	-	●
F	318 999	Dirt sieve for hinged lid MARCO, PE-HD, blue						
G	318 998	Replacement lid for hinged lid funnel MARCO, PE-HD, blue						
H	319 000	Dirt sieve for hinged lid MARCO, stainless steel, 105 mm, fine-mesh						
I	318 989	Dirt sieve for hinged lid MARCO, PE-HD-EL, black						
J	318 988	Replacement lid for hinged lid funnel MARCO, PE-HD-EL, black						

Safety Funnel MARCO Disposal-Sets

Collect liquid HPLC waste safely: Sets including container and funnel, ready for immediate use - without time-consuming assembling of a configuration.



Even more selection

Scan the **QR code** to go directly to the funnel sets section of our website.

Safety Funnel MARCO Disposal-Sets

A 307 316

Hinged lid funnel MARCO

- GL 45 Thread
- Removable sieve
- PE-HD



Waste canister

- GL 45 Thread
- 2,5 Litre
- PE-HD

Fig.	Part No.	Description	Contents		
A	307 316	Funnel Disposal-Set	Quantity	Description	See also
			1x	Hinged lid funnel MARCO, GL 45, PE-HD, with removable sieve	► Page 106
			1x	2,5 Litre canister, GL 45, PE-HD	► Page 136
	307 317	Funnel Disposal-Set	Quantity	Description	See also
			1x	Hinged lid funnel MARCO, GL 45, PE-HD, with removable sieve	► Page 106
			1x	5 Litre canister, GL 45, PE-HD	► Page 136
	307 318	Funnel Disposal-Set	Quantity	Description	See also
			1x	Hinged lid funnel MARCO, GL 45, PE-HD, with removable sieve	► Page 106
			1x	10 Litre canister, GL 45, PE-HD	► Page 136

ARNOLD Ball-Valve Funnel with Hinged Lid

Strong protection when collecting liquid waste!



Safety Funnel ARNOLD Technical Details

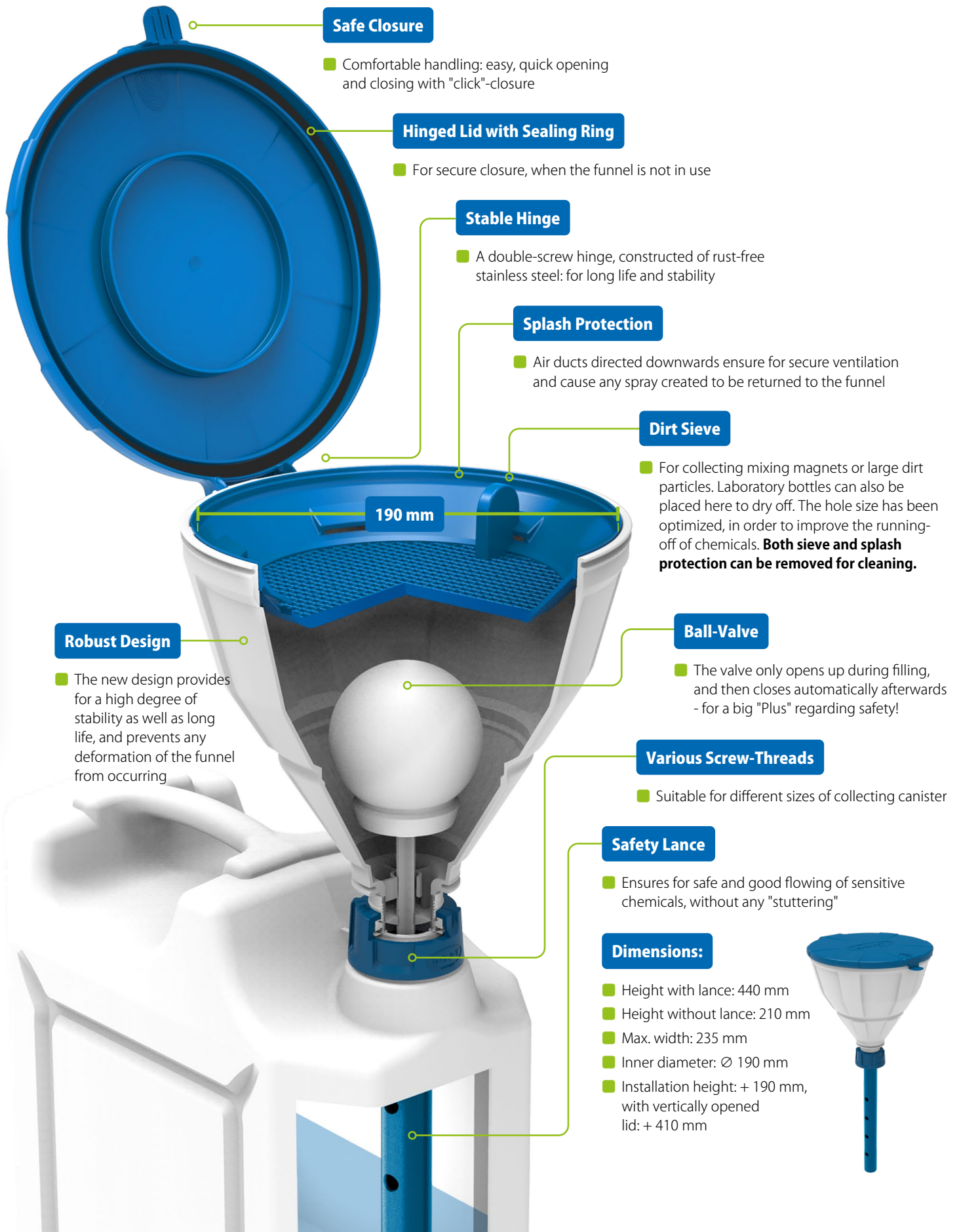

Safe Closure

- Comfortable handling: easy, quick opening and closing with "click"-closure

Hinged Lid with Sealing Ring

- For secure closure, when the funnel is not in use

Stable Hinge

- A double-screw hinge, constructed of rust-free stainless steel: for long life and stability

Splash Protection

- Air ducts directed downwards ensure for secure ventilation and cause any spray created to be returned to the funnel

Dirt Sieve

- For collecting mixing magnets or large dirt particles. Laboratory bottles can also be placed here to dry off. The hole size has been optimized, in order to improve the running-off of chemicals. **Both sieve and splash protection can be removed for cleaning.**

190 mm

Robust Design

- The new design provides for a high degree of stability as well as long life, and prevents any deformation of the funnel from occurring

Ball-Valve

- The valve only opens up during filling, and then closes automatically afterwards - for a big "Plus" regarding safety!

Various Screw-Threads

- Suitable for different sizes of collecting canister

Safety Lance

- Ensures for safe and good flowing of sensitive chemicals, without any "stuttering"

Dimensions:

- Height with lance: 440 mm
- Height without lance: 210 mm
- Max. width: 235 mm
- Inner diameter: \varnothing 190 mm
- Installation height: + 190 mm, with vertically opened lid: + 410 mm



Safety Funnel ARNOLD Ordering Information

A 317 642



B 317 622



D 319 001



F 319 002

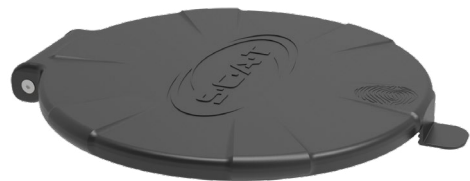

E 317 640



G 317 620



Safety Funnel ARNOLD

Ordering Information



Informations about "delivery with adapter":

The safety funnel ARNOLD is available in various container screw-thread sizes. In order that we may produce in an environmentally-friendly and economic manner, certain variants are delivered together with a screw-thread adapter. Those to which this applies can be seen in the column "delivery with adapter".

Fig.	Part No.	Description	Screw-Thread of Container	Lance (220 mm)	Electrostatic conductive	Material	Delivery with Adapter
A	317 642	Ball-valve funnel ARNOLD	GL 45	●	-	PE-HD	-
B	317 622	Ball-valve funnel ARNOLD	GL 45	●	●	PE-HD-EL	-
	317 638	Ball-valve funnel ARNOLD	GL 45	-	●	PE-HD-EL	-
	317 649	Ball-valve funnel ARNOLD	S 50	●	-	PE-HD	●
	317 629	Ball-valve funnel ARNOLD	S 50	●	●	PE-HD-EL	●
	317 644	Ball-valve funnel ARNOLD	S 51	●	-	PE-HD	●
	317 624	Ball-valve funnel ARNOLD	S 51	●	●	PE-HD-EL	●
	317 632	Ball-valve funnel ARNOLD	B 53	●	-	PE-HD	●
	317 645	Ball-valve funnel ARNOLD	S 55	●	-	PE-HD	-
	317 625	Ball-valve funnel ARNOLD	S 55	●	●	PE-HD-EL	-
	317 641	Ball-valve funnel ARNOLD	S 60/61	●	-	PE-HD	-
	317 621	Ball-valve funnel ARNOLD	S 60/61	●	●	PE-HD-EL	-
	317 646	Ball-valve funnel ARNOLD	S 65	●	-	PE-HD	●
	317 626	Ball-valve funnel ARNOLD	S 65	●	●	PE-HD-EL	●
	317 648	Ball-valve funnel ARNOLD	S 70/71	●	-	PE-HD	●
	317 628	Ball-valve funnel ARNOLD	S 70/71	●	●	PE-HD-EL	●
	317 647	Ball-valve funnel ARNOLD	B 83	●	-	PE-HD	●
	317 627	Ball-valve funnel ARNOLD	B 83	●	●	PE-HD-EL	●
	317 643	Ball-valve funnel ARNOLD	S 90	●	-	PE-HD	●
	317 623	Ball-valve funnel ARNOLD	S 90	●	●	PE-HD-EL	●
C	317 635	Ball-valve funnel ARNOLD	S 95	●	●	PE-HD-EL	●
	317 630	Ball-valve funnel ARNOLD	Double thread R2" BSP/G2" + 2" TriSure	-	●	PE-HD-EL	-
D	319 001	Replacement lid for ball-valve funnel ARNOLD, PE-HD, blue					
E	317 640	Replacement sieve incl. splash protection for ball-valve funnel ARNOLD, PE-HD, blue					
F	319 002	Replacement lid for ball-valve funnel ARNOLD, PE-HD-EL, black					
G	317 620	Replacement sieve incl. splash protection for ball-valve funnel ARNOLD, PE-HD-EL, black					

Safety Funnel ARNOLD Disposal-Set

Collect liquid HPLC waste safely: Sets including container and funnel, ready for immediate use - without time-consuming assembling of a configuration.



Even more selection

Scan the **QR code** to go directly to the funnel sets section of our website.



Safety Funnel ARNOLD Disposal-Set

A 307 450



Ball-valve funnel ARNOLD

- S 55 Thread
- Removable sieve
- PE-HD

Waste canister

- S 55 Thread
- 10 Litre
- PE-HD

Fig.	Part No.	Description	Contents		
A	307 450	Funnel Disposal-Set	Quantity	Description	See also
			1x	Safety Funnel with ball-valve ARNOLD, S 55, PE-HD, sieve & splash protection	► Page 113
			1x	10 Litre canister S 55, PE-HD	► Page 137

Funnel ARNOLD for Barrels

Double thread R2" BSP/G2" (m) + BCS 56x4 (m)

Version without Ball-Valve

- ARNOLD funnels without ball valve are adapted for high flow rates or highly viscous liquids
- Equipped with an additional, removable dirt sieve (instead of ball-valve)

A 317 631



Double Thread

- R2" BSP/G2" (m) + BCS 56x4 (m)



Fig.	Part No.	Description	Material
A	317 631	Barrel-Funnel ARNOLD with lid, double thread R2" BSP/G2" (m) + BCS 56x4 (m), with splash protection, removable sieve and grounding cable, 2 sieves	PE-HD-EL
	317 630	Barrel-Funnel ARNOLD with ball-valve and lid, double thread R2" BSP/G2" (m) + BCS 56x4 (m), with splash protection, removable sieve and grounding cable	PE-HD-EL

Алматы (727)345-47-04
 Ангарск (3955)60-70-56
 Архангельск (8182)63-90-72
 Астрахань (8512)99-46-04
 Барнаул (3852)73-04-60
 Белгород (4722)40-23-64
 Благовещенск (4162)22-76-07
 Брянск (4832)59-03-52
 Владивосток (423)249-28-31
 Владикавказ (8672)28-90-48
 Владимир (4922)49-43-18
 Волгоград (844)278-03-48
 Вологда (8172)26-41-59
 Воронеж (473)204-51-73
 Екатеринбург (343)384-55-89

Иваново (4932)77-34-06
 Ижевск (3412)26-03-58
 Иркутск (395)279-98-46
 Казань (843)206-01-48
 Калининград (4012)72-03-81
 Калуга (4842)92-23-67
 Кемерово (3842)65-04-62
 Киров (8332)68-02-04
 Коломна (4966)23-41-49
 Кострома (4942)77-07-48
 Краснодар (861)203-40-90
 Красноярск (391)204-63-61
 Курск (4712)77-13-04
 Курган (3522)50-90-47
 Липецк (4742)52-20-81

Магнитогорск (3519)55-03-13
 Москва (495)268-04-70
 Мурманск (8152)59-64-93
 Набережные Челны (8552)20-53-41
 Нижний Новгород (831)429-08-12
 Новокузнецк (3843)20-46-81
 Ноябрьск (3496)41-32-12
 Новосибирск (383)227-86-73
 Омск (3812)21-46-40
 Орел (4862)44-53-42
 Оренбург (3532)37-68-04
 Пенза (8412)22-31-16
 Петрозаводск (8142)55-98-37
 Псков (8112)59-10-37
 Пермь (342)205-81-47

Ростов-на-Дону (863)308-18-15
 Рязань (4912)46-61-64
 Самара (846)206-03-16
 Санкт-Петербург (812)309-46-40
 Саратов (845)249-38-78
 Севастополь (8692)22-31-93
 Саранск (8342)22-96-24
 Симферополь (3652)67-13-56
 Смоленск (4812)29-41-54
 Сочи (862)225-72-31
 Ставрополь (8652)20-65-13
 Сургут (3462)77-98-35
 Сыктывкар (8212)25-95-17
 Тамбов (4752)50-40-97
 Тверь (4822)63-31-35

Тольятти (8482)63-91-07
 Томск (3822)98-41-53
 Тула (4872)33-79-87
 Тюмень (3452)66-21-18
 Ульяновск (8422)24-23-59
 Улан-Уда (3012)59-97-51
 Уфа (347)229-48-12
 Хабаровск (4212)92-98-04
 Чебоксары (8352)28-53-07
 Челябинск (351)202-03-61
 Череповец (8202)49-02-64
 Чита (3022)38-34-83
 Якутск (4112)23-90-97
 Ярославль (4852)69-52-93

Россия +7(495)268-04-70

Казахстан +7(727)345-47-04

Беларусь +(375)257-127-884

Узбекистан +998(71)205-18-59

Киргизия +996(312)96-26-47

<https://scat.nt-rt.ru/> || sqt@nt-rt.ru

Funnel ARNOLD with Level Control

For safe filling of barrels and large containers

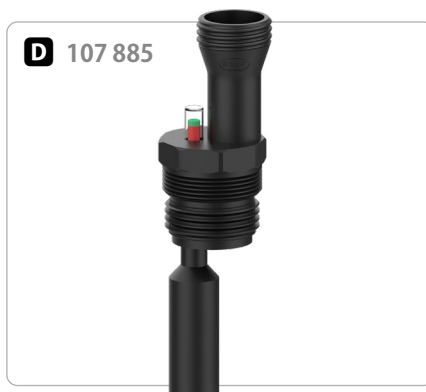
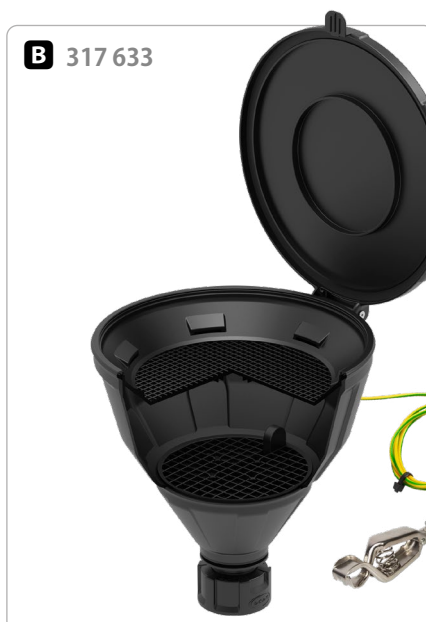

Fig.	Part No.	Description	Material
A	317 636	Funnel ARNOLD GL 45 with lid, 2 sieves	PE-HD
B	317 633	Funnel ARNOLD GL 45 with lid, 2 sieves	PE-HD-EL
C	107 892	Adapter for funnels with mechanical level control, barrel double thread R2" BSP/G2" (m) to GL 45 (m)	PP
D	107 885	Adapter for funnels with mechanical level control, barrel double thread R2" BSP/G2" (m) to GL 45 (m)	PE-HD-EL
	317 660	Set consisting of A and C	-
	317 650	Set consisting of B and D	-



You might also be interested in

Further adapters and mechanical level control on **page 129**.

