

WE DELIVER CONTAINERS. SAFE!



Perfect Protection when Handling Liquids.

From bottles made of break-proof glass, for safe extraction of solvents to supply the HPLC, to electrostatic conductive, 60 litre canisters with level control for disposal, SCAT offers a wide range of safety containers for all common requirements in your everyday laboratory work.

Алматы (727)345-47-04
Ангарск (3955)60-70-56
Архангельск (8182)63-90-72
Астрахань (8512)99-46-04
Барнаул (3852)73-04-60
Белгород (4722)40-23-64
Благовещенск (4162)22-76-07
Брянск (4832)59-03-52
Владивосток (423)249-28-31
Владикавказ (8672)28-90-48
Владимир (4922)49-43-18
Волгоград (844)278-03-48
Вологда (8172)26-41-59
Воронеж (473)204-51-73
Екатеринбург (343)384-55-89

Иваново (4932)77-34-06
Ижевск (3412)26-03-58
Иркутск (395)279-98-46
Казань (843)206-01-48
Калининград (4012)72-03-81
Калуга (4842)92-23-67
Кемерово (3842)65-04-62
Киров (8332)68-02-04
Коломна (4966)23-41-49
Кострома (4942)77-07-48
Краснодар (861)203-40-90
Красноярск (391)204-63-61
Курск (4712)77-13-04
Курган (3522)50-90-47
Липецк (4742)52-20-81

Магнитогорск (3519)55-03-13
Москва (495)268-04-70
Мурманск (8152)59-64-93
Набережные Челны (8552)20-53-41
Нижний Новгород (831)429-08-12
Новокузнецк (3843)20-46-81
Ноябрьск (3496)41-32-12
Новосибирск (383)227-86-73
Омск (3812)21-46-40
Орел (4862)44-53-42
Оренбург (3532)37-68-04
Пенза (8412)22-31-16
Петрозаводск (8142)55-98-37
Псков (8112)59-10-37
Пермь (342)205-81-47

Ростов-на-Дону (863)308-18-15
Рязань (4912)46-61-64
Самара (846)206-03-16
Санкт-Петербург (812)309-46-40
Саратов (845)249-38-78
Севастополь (8692)22-31-93
Саранск (8342)22-96-24
Симферополь (3652)67-13-56
Смоленск (4812)29-41-54
Сочи (862)225-72-31
Ставрополь (8652)20-65-13
Сургут (3462)77-98-35
Сыктывкар (8212)25-95-17
Тамбов (4752)50-40-97
Тверь (4822)63-31-35

Тольятти (8482)63-91-07
Томск (3822)98-41-53
Тула (4872)33-79-87
Тюмень (3452)66-21-18
Ульяновск (8422)24-23-59
Улан-Удэ (3012)59-97-51
Уфа (347)229-48-12
Хабаровск (4212)92-98-04
Чебоксары (8352)28-53-07
Челябинск (351)202-03-61
Череповец (8202)49-02-64
Чита (3022)38-34-83
Якутск (4112)23-90-97
Ярославль (4852)69-52-93

Россия +7(495)268-04-70

Казахстан +7(727)345-47-04

Беларусь +375)257-127-884

Узбекистан +998(71)205-18-59

Киргизия +996(312)96-26-47

<https://scat.nt-rt.ru/> || sqt@nt-rt.ru

Containers

Store and collect chemicals and liquid waste safely.



Scan the QR code and download a practical PDF overview of the laboratory glass range!



Scan the QR code and download a practical PDF overview of the canister range!



Laboratory Glass Bottles Clear Glass



GL 45

- 250 ml - 1 L
- Clear glass
- Round

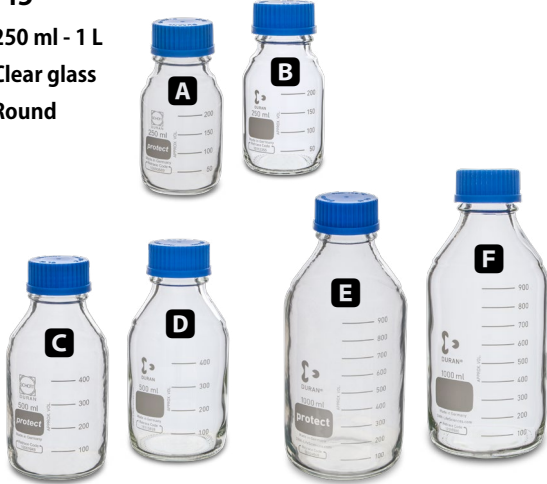

Clear Glass, Round

- Storage capacity from 250 ml up to 10 L

Break-Proof

- Safe from glass breakage due to protective coating, see table

GL 45

- 2 L - 10 L
- Clear glass
- Round



Fig.	Part No.	Description	Thread	Content	Glass Type	Form	Protective Coating
A	101 994	Laboratory bottle DURAN®, GL 45, 250 ml	GL 45	250 ml	Clear glass	Round	Yes
B	501 117	Laboratory bottle DURAN®, GL 45, 250 ml	GL 45	250 ml	Clear glass	Round	-
C	101 995	Laboratory bottle DURAN®, GL 45, 500 ml	GL 45	500 ml	Clear glass	Round	Yes
D	501 116	Laboratory bottle DURAN®, GL 45, 500 ml	GL 45	500 ml	Clear glass	Round	-
E	101 996	Laboratory bottle DURAN®, GL 45, 1 L	GL 45	1 Litre	Clear glass	Round	Yes
F	501 113	Laboratory bottle DURAN®, GL 45, 1 L	GL 45	1 Litre	Clear glass	Round	-
G	101 997	Laboratory bottle DURAN®, GL 45, 2 L	GL 45	2 Litre	Clear glass	Round	Yes
H	501 118	Laboratory bottle DURAN®, GL 45, 2 L	GL 45	2 Litre	Clear glass	Round	-
I	101 998	Laboratory bottle DURAN®, GL 45, 5 L	GL 45	5 Litre	Clear glass	Round	Yes
	501 125	Laboratory bottle DURAN®, GL 45, 5 L	GL 45	5 Litre	Clear glass	Round	-
J	501 126	Laboratory bottle DURAN®, GL 45, 10 L	GL 45	10 Litre	Clear glass	Round	-

Laboratory Glass Bottles

Clear Glass, Brown Glass

GL 45, GL 28

GL 45

- 250 ml - 1 L
- Clear glass
- Square

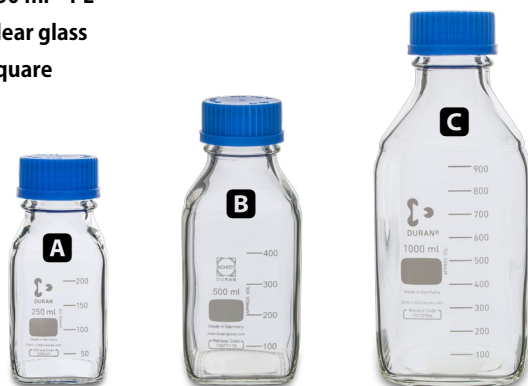

GL 45

- 250 ml - 2 L
- Brown glass
- Round



GL 45

- Screw cap



GL 28

- 100 ml
- Brown glass
- Round



GL 45

- 1 L
- Clear or brown glass
- Ergonomic



Duran® YOUTILITY

- The ergonomic form simplifies the grasp of lab bottles
- Changeable and coloured rubber rings at the bottleneck are some clever marking-labels to get organised in the lab



Fig.	Part No.	Description	Thread	Content	Glass Type	Form	Protective Coating
A	501 112	Laboratory bottle DURAN®, GL 45, 250 ml	GL 45	250 ml	Clear glass	Square	-
B	501 115	Laboratory bottle DURAN®, GL 45, 500 ml	GL 45	500 ml	Clear glass	Square	-
C	501 110	Laboratory bottle DURAN®, GL 45, 1 L	GL 45	1 Litre	Clear glass	Square	-
D	501 121	Laboratory bottle DURAN®, GL 45, 250 ml	GL 45	250 ml	Brown glass	Round	-
E	501 120	Laboratory bottle DURAN®, GL 45, 500 ml	GL 45	500 ml	Brown glass	Round	-
F	501 119	Laboratory bottle DURAN®, GL 45, 1 L	GL 45	1 Litre	Brown glass	Round	-
	501 123	Laboratory bottle DURAN®, GL 45, 2 L	GL 45	2 Litre	Brown glass	Round	-
G	199 011	Screw cap DURAN®	GL 45	-	-	-	-
H	501 127	Laboratory bottle, GL 28, 100 ml	GL 28	100 ml	Brown glass	Round	-
I	501 131	Laboratory bottle DURAN® YOUTILITY, GL 45, 1 L	GL 45	1 Litre	Clear glass	Ergon.	-
	501 130	Laboratory bottle DURAN® YOUTILITY, GL 45, 1 L	GL 45	1 Litre	Brown glass	Ergon.	-
J	501 154	Bottle Tag, GL 45, Multipack, 2x Blue, 2x Purple, 2x Green, 2x Red, 2x Orange, 2x Yellow, 2x Black, 2x White					

Laboratory Glass Bottles Wide Mouth

 **GLS 80**

GLS 80

- 500 ml - 2 L
- Clear glass
- Round
- Wide mouth



Clear Glass

- Storage capacity from 500 ml up to 2 L
- GLS 80, wide diameter of bottle neck

GLS 80

- 500 ml - 2 L
- Brown glass
- Round
- Wide mouth



Brown Glass

- Storage capacity from 500 ml up to 2 L
- GLS 80, wide diameter of bottle neck

Fig.	Part No.	Description	Thread	Content	Glass Type	Form	Protective Coating
A	501 150	Laboratory bottle DURAN®, GLS 80, 500 ml	GLS 80	500 ml	Clear glass	Round	-
B	501 156	Laboratory bottle DURAN®, GLS 80, 500 ml	GLS 80	500 ml	Brown glass	Round	-
C	501 151	Laboratory bottle DURAN®, GLS 80, 1 L	GLS 80	1 Litre	Clear glass	Round	-
D	501 157	Laboratory bottle DURAN®, GLS 80, 1 L	GLS 80	1 Litre	Brown glass	Round	-
E	501 152	Laboratory bottle DURAN®, GLS 80, 2 L	GLS 80	2 Litre	Clear glass	Round	-
F	501 158	Laboratory bottle DURAN®, GLS 80, 2 L	GLS 80	2 Litre	Brown glass	Round	-

Laboratory Glass Bottles Purging Manifold

✗ Negative Example

Open purging bottle



Common purging process:

- When purging a HPLC system, Safety Caps with capillaries are hung loosely in the purging bottle
- Thus interrupt the SCAT system
- As a result, harmful vapours get into the laboratory ambient air and endanger work safety

✓ Positive Example

Hermetically sealed purging bottle

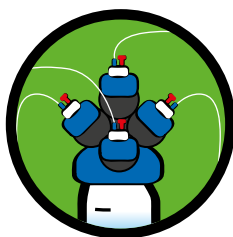

Purging process with the SCAT purging manifold:

- Install up to 4 Safety Caps on your purging bottle for safe and easy handling. Capillaries are reliably fixed and solvent filters have enough space due to the wide GLS 80 opening.
- The SCAT system for solvent safety stays permanently closed, the "safety chain" remains intact during the purging process
- No dangers, no contamination - protects people, environment and HPLC system

GLS 80, GL 45



A 106 660



B 306 509



Flexible

- Simply close unused connections with the standard screw cap. (Not included in the scope of delivery).

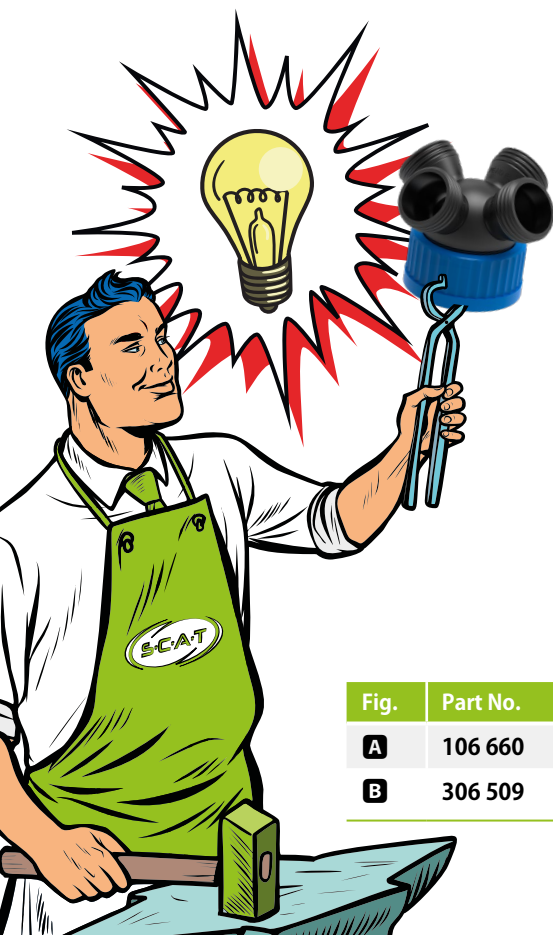

Fig.	Part No.	Description
A	106 660	Purging manifold WERNER, GLS 80 (f), 4x GL 45 (m), PE-HD-EL
B	306 509	Purging manifold NICOLE, GL 45 (f), 4x GL 45 (m), PE-HD-EL

Canisters PE-HD

GL 45, S 50

GL 45

- 2.5 - 10 L
- PE-HD
- UN-Y



S 50

- 5 L
- PP

Space-saving Canisters

- Only 65 mm wide!
- Optional with level control

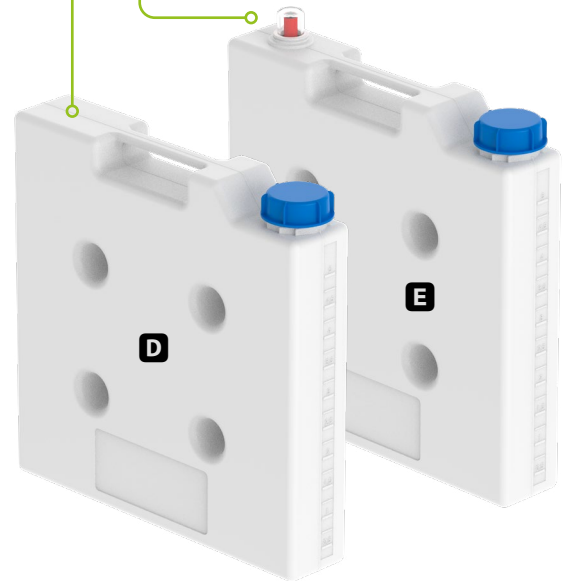

Order also

- Base for 2 space-saving canisters



Consistent with canisters

- Electrostatic conductive Canistes from **page 142**
- Safety Waste Caps from **page 68**
- Safety Funnels from **page 94**
- Thread Adapters from **page 164**
- Collecting Trays and Stirrers from **page 148**

Fig.	Part No.	Thread	Content L	Material	Colour	UN Approval	Specific Feature	Dimensions in mm W x H x D
A	107 950	GL 45	2.5	PE-HD	Nature	Yes	UN-Y approval	115 x 210 x 150
B	107 951	GL 45	5	PE-HD	Nature	Yes	UN-Y approval	150 x 250 x 195
C	107 952	GL 45	10	PE-HD	Nature	Yes	UN-Y approval	190 x 305 x 230
D	107 998	S 50	5	PP	Nature	No	Space-saving	65 x 335 x 335
E	108 945	S 50	5	PP	Nature	No	With floater	65 x 405 x 335
F	199 050			Stainless steel	Steel			141 x 130 x 200

Canisters PE-HD

S 51, B 53, S 55

S 51

-  5 L
-  PE-HD
-  UN-X



B 53

-  2 L
-  PE-HD





S 55

-  5 - 10 L
-  PE-HD
-  UN-X
-  UN-Y



S 55

-  5 - 10 L
-  F-PE-HD
-  UN-X

Fluorinated Canister

-  Against weight loss of content. Fluorination on both sides protect the canisters plastic walls from permeation of chemicals.



Fig.	Part No.	Thread	Content L	Material	Colour	UN Approval	Specific Feature	Dimensions in mm W x H x D
A	107 958	S 51	5	PE-HD	Nature	Yes	UN-X approval	145 x 250 x 190
B	107 711	B 53	2	PE-HD	Nature	No		119 x 260 x 119
C	108 175	S 55	5	PE-HD	Nature	Yes	UN-X approval	182 x 240 x 162
D	107 957	S 55	5	PE-HD	Nature	Yes	UN-Y approval	160 x 230 x 185
E	107 955	S 55	10	PE-HD	Nature	Yes	UN-Y approval	185 x 305 x 225
F	107 933	S 55	5	F-PE-HD	Nature	Yes	UN-X approval Fluorination on both sides	145 x 250 x 190
G	108 189	S 55	10	F-PE-HD	Nature	Yes	UN-X approval Fluorination on both sides	190 x 310 x 230

Canisters PE-HD



Fig.	Part No.	Thread	Content L	Material	Colour	UN Approval	Specific Feature	Dimensions in mm W x H x D
A	108 227	S 60/61	5	PE-HD	Nature	Yes	UN-X approval	164 x 235 x 185
B	107 731	S 60/61	12	PE-HD	Nature	Yes	UN-X approval	200 x 350 x 235
C	107 956	S 60/61	20	PE-HD	Nature	Yes	UN-X approval	260 x 390 x 289
D	108 056	S 60/61	20	PE-HD	Nature	No	With floater	260 x 455 x 285
E	107 959	S 60/61	30	PE-HD	Nature	Yes	UN-Y approval	290 x 400 x 380
F	108 115	S 60/61 & GL 45	30	PE-HD	Nature	No	Double closure	290 x 400 x 380

Canisters

PE-HD

 **S 65**

Round Canister, 60 Litres!

- Handles on both sides, for carrying by 2 people

S 65

- 5 - 60 L
- PE-HD

Handle Can

- Safe and easy handling



Fig.	Part No.	Thread	Content L	Material	Colour	UN Approval	Specific Feature	Dimensions in mm W x H x D
A	107 722	S 65	5	PE-HD	Nature	No	With handle and scale	167 x 330 x 167
B	107 704	S 65	10	PE-HD	Nature	No	With handle and scale	205 x 430 x 205
C	107 720	S 65	25	PE-HD	Nature	No	With carrying handles and scale	278 x 580 x 278
D	107 721	S 65	60	PE-HD	Nature	No	With carrying handles and scale	350 x 825 x 350

Canisters PE-HD

 **S 70/71, B 83**

S 70/71

- 20 - 60 L
- PE-HD
- UN-Y

Low Construction

- Space-saving

60 Litres!

- Handles on both sides, for carrying by 2 people



B 83

- 4 - 50 L
- PE-HD, PP
- UN-Y

Round Canister, 50 Litres!

- Handles on both sides, for carrying by 2 people



Fig.	Part No.	Thread	Content L	Material	Colour	UN Approval	Specific Feature	Dimensions in mm W x H x D
A	107 713	S 70/71	20	PE-HD	Nature	Yes	UN-Y approval	283 x 292 x 376
B	107 710	S 70/71	60	PE-HD	Nature	Yes	UN-Y approval	330 x 635 x 370
C	107 712	B 83	4	PE-HD	Nature	No		155 x 338 x 155
D	107 706	B 83	10	PP	Nature	No	With carrying handles	250 x 390 x 250
E	107 730	B 83	50	PP	Nature	No	With carrying handles	380 x 680 x 380

Canisters PE-HD

S 90, S 95

S 90

- 10 L
- PE-HD
- UN-Y

Handle Can

- Safe and easy handling



XXL Safety Waste Caps

Safety Waste Caps in chapter HPLC-Disposal from **page 62**

Safety Waste Caps S 90 on **page 84**

Safety Waste Caps S S 95 on **page 85**

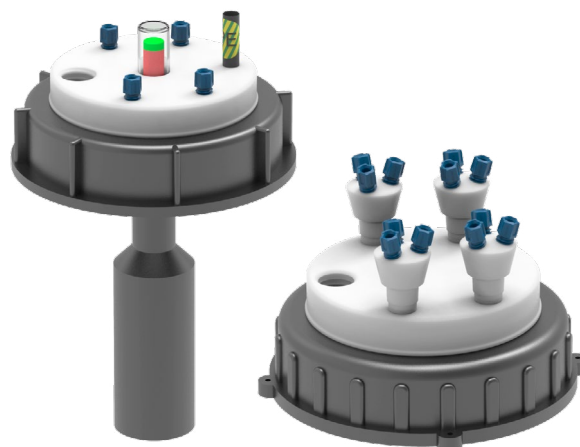

S 95

- 5 - 20 L
- PE-HD
- UN-Y

Side-Handle

- Simplifies carrying or transposing



Fig.	Part No.	Thread	Content L	Material	Colour	UN Approval	Specific Feature	Dimensions in mm W x H x D
A	108 020	S 90	10	PE-HD	Nature	Yes	UN-Y approval	195 x 380 x 195
B	107 707	S 95	5	PE-HD	Nature	Yes	UN-Y approval	170 x 310 x 170
C	107 733	S 95	20	PE-HD	Nature	No		260 x 390 x 290

Canisters

Electrostatic conductive, PE-HD-EL



S 50

- 10 L
- PE-HD-EL
- UN-X

Straight Opening

- No angled thread adapters required



Level Control

- Integrated viewing strip shows the filling level

S 50

- 5 L
- PE-HD-EL

Space-saving Canisters

- Only 65 mm wide!
- Optional with level control



Order also

- Base for 2 space-saving canisters



Consistent with canisters

- Do not forget grounding! Grounding cables on **page 166**
- Safety Waste Caps from **page 62**
- Safety Funnels from **page 100**
- Thread Adapters from **page 164**
- Collecting Trays and Stirrers from **page 148**

Fig.	Part No.	Thread	Content L	Material	Colour	UN Approval	Specific Feature	Dimensions in mm W x H x D
A	108 421	S 50	10	PE-HD-EL	Black	Yes	UN-X approval with viewing strip	190 x 315 x 230
B	108 317	S 50	5	PE-HD-EL	Black	No	Space-saving	65 x 335 x 335
C	108 950	S 50	5	PE-HD-EL	Black	No	With floater	65 x 405 x 335
D	199 050			Stainless steel	Steel			141 x 130 x 200

Canisters

Electrostatic conductive, PE-HD-EL

S 60/61



Fig.	Part No.	Thread	Content L	Material	Colour	UN Approval	Specific Feature	Dimensions in mm W x H x D
A	108 329	S 60/61	5	PE-HD-EL	Black	Yes	UN-Y approval, straight opening	165 x 241 x 195
B	108 330	S 60/61	10	PE-HD-EL	Black	Yes	UN-Y approval, straight opening	192 x 311 x 232
C	107 953	S 60/61	10	PE-HD-EL	Black	Yes	UN-Y approval	185 x 265 x 290
D	108 216	S 60/61	10	PE-HD-EL	Black	No	With red marking strip	185 x 265 x 290
E	108 217	S 60/61	10	PE-HD-EL	Black	No	With green marking strip	185 x 265 x 290
F	108 215	S 60/61	10	PE-HD-EL	Black	No	With yellow marking strip	185 x 265 x 290
G	108 214	S 60/61	10	PE-HD-EL	Black	No	With blue marking strip	185 x 265 x 290

Canisters Electrostatic conductive, PE-HD-EL



S 60/61

- 10 L
- PE-HD-EL

Level Control

- Integrated floater signalizes when the container is full

S 60/61

- 10 L
- PE-HD-EL

Sleeve for Sensor

- Removable sleeve
- Suitable rod sensor part no. 108 178 see **page 123**

S 60/61

- 20 L
- PE-HD-EL
- UN-Y

Straight Opening

- No angled thread adapters required

Level Control

- Integrated floater signalizes when the container is full

Fig.	Part No.	Thread	Content L	Material	Colour	UN Approval	Specific Feature	Dimensions in mm W x H x D
A	108 042	S 60/61	10	PE-HD-EL	Black	No	With floater	185 x 265 x 290
B	108 042-S1	S 60/61	10	PE-HD-EL	Black	No	With sleeve for sensor 108 178	185 x 265 x 290
C	108 331	S 60/61	20	PE-HD-EL	Black	Yes	UN-Y approval, straight opening	290 x 399 x 245
D	108 027	S 60/61	20	PE-HD-EL	Black	Yes	UN-Y approval	185 x 500 x 290
E	108 043	S 60/61	20	PE-HD-EL	Black	No	With floater	185 x 500 x 290

Canisters

Electrostatic conductive, PE-HD-EL

S 60/61

- 30 L
- PE-HD-EL
- UN-Y

Level Control

- Integrated floater signalizes when the container is full



S 90

- 10 L
- PE-HD-EL
- UN-Y

Handle Can

- Safe and easy handling

Level Control

- Integrated viewing strip shows the filling level



Handle of non-conductive plastic. The grounding strap is required to securely ground the canister. This can be found on **page 167**.

S 60/61, S 70/71, S 90



Safety Note: As per TRGS 727, Para. 4.5.5, the largest container volume permitted within Zone 1, for non-conducting containers, is 5 litres. There may also be no deviation from this regulation when working with aqueous-based solutions that are highly conductive, as work involving exposed flammable liquids creates an explosive atmosphere close to the container, as is generally defined for Zone 1.

S 70/71

- 60 L
- PE-HD-EL
- UN-Y

Level Control

- Integrated floater signalizes when the container is full

Handles

- Handles on both sides, for carrying by 2 people



Fig.	Part No.	Thread	Content L	Material	Colour	UN Approval	Specific Feature	Dimensions in mm W x H x D
A	108 192	S 60/61	30	PE-HD-EL	Black	Yes	UN-Y approval	240 x 455 x 364
B	108 193	S 60/61	30	PE-HD-EL	Black	No	With floater	240 x 455 x 364
C	107 940	S 70/71	60	PE-HD-EL	Black	Yes	UN-Y approval	330 x 625 x 396
D	107 740	S 70/71	60	PE-HD-EL	Black	No	With floater	330 x 690 x 395
E	108 420	S 90	10	PE-HD-EL	Black	Yes	UN-Y approval With viewing strip	195 x 380 x 195

Politainer

Space-saving foldable Canisters

Good for the laboratory - good for the climate!

The Politainer can ideally be stored space-saving prior to filling and it is stackable when filled. The Politainer unfolds automatically during filling – the integrated handle ensures a safe transport and emptying free of danger. Through the small volume in its original condition you save shipping costs. The carton can be used several times and that increases cost effectiveness. The combi-packaging uses 50 % – 75 % less material than rigid container and is therefore environmentally friendly. When using the strong covering box the Politainer is UN approved.

Clever & Smart

- Space-saving storage
- Quickly ready for use



GL 38

- 5 L
- PE-LD / EVA Copolymer
- UN-Y

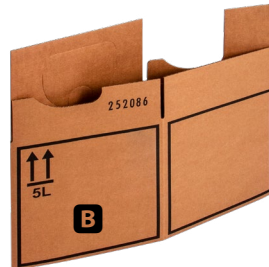

GL 38

- 10 L
- PE-LD / EVA Copolymer
- UN-Y



Politainer Space-saving foldable Canisters

S 60/61

S 60/61

-  10 L
-  PE-LD / EVA Copolymer
-  UN-Y



S 60/61

-  20 L
-  PE-LD / EVA Copolymer
-  UN-Y



Safety Waste Caps

S 60/61 on **page 78**.



Fig.	Part No.	Description	Thread	Content L	Material	Colour	UN-Y Approval	Dimensions in mm W x H x D
A	107 330	Politainer	GL 38	5	PE-LD / EVA Copolymer	Nature	Yes, but only with Box 107 334	178 x 178 x 178
B	107 334	Box for Politainer		5	Carton	Nature	Yes	189 x 186 x 190
C	107 331	Politainer	GL 38	10	PE-LD / EVA Copolymer	Nature	Yes, but only with Box 107 335	228 x 228 x 228
D	107 332	Politainer	S 60/61	10	PE-LD / EVA Copolymer	Nature	Yes, but only with Box 107 335	228 x 228 x 228
E	107 335	Box for Politainer		10	Carton	Nature	Yes	236 x 236 x 236
F	107 333	Politainer	S 60/61	20	PE-LD / EVA Copolymer	Nature	Yes, but only with Box 107 336	285 x 285 x 285
G	107 336	Box for Politainer		20	Carton	Nature	Yes	290 x 290 x 306

Collecting Trays The Safety Waste Assurance!

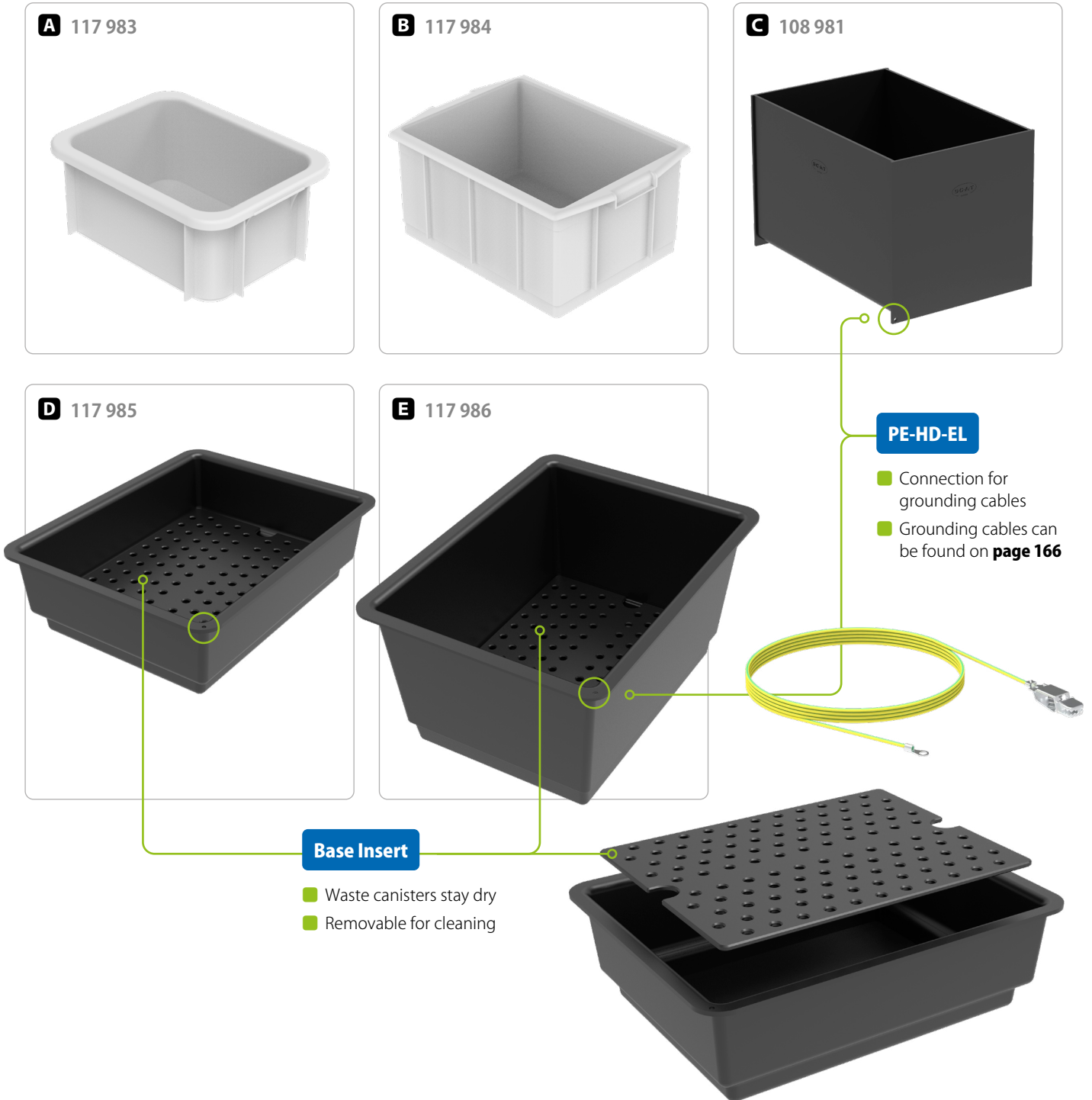

Fig.	Part No.	Description	Material	Colour	Inner Dimensions in mm W x H x D	Outer Dimensions in mm W x H x D
A	117 983	Collecting tray	PE-HD	White	235 x 160 x 335	300 x 170 x 400
B	117 984	Collecting tray	PE-HD	White	290 x 200 x 385	340 x 210 x 465
C	108 981	Collecting tray	PE-HD-EL	Black	200 x 200 x 300	225 x 215 x 325
D	117 985	Collecting tray with base insert	PE-HD-EL	Black	285 x 95 x 385	355 x 135 x 445
E	117 986	Collecting tray with base insert	PE-HD-EL	Black	295 x 200 x 415	365 x 240 x 490

Алматы (727)345-47-04
 Ангарск (3955)60-70-56
 Архангельск (8182)63-90-72
 Астрахань (8512)99-46-04
 Барнаул (3852)73-04-60
 Белгород (4722)40-23-64
 Благовещенск (4162)22-76-07
 Брянск (4832)59-03-52
 Владивосток (423)249-28-31
 Владикавказ (8672)28-90-48
 Владимир (4922)49-43-18
 Волгоград (844)278-03-48
 Вологда (8172)26-41-59
 Воронеж (473)204-51-73
 Екатеринбург (343)384-55-89

Иваново (4932)77-34-06
 Ижевск (3412)26-03-58
 Иркутск (395)279-98-46
 Казань (843)206-01-48
 Калининград (4012)72-03-81
 Калуга (4842)92-23-67
 Кемерово (3842)65-04-62
 Киров (8332)68-02-04
 Коломна (4966)23-41-49
 Кострома (4942)77-07-48
 Краснодар (861)203-40-90
 Красноярск (391)204-63-61
 Курск (4712)77-13-04
 Курган (3522)50-90-47
 Липецк (4742)52-20-81

Магнитогорск (3519)55-03-13
 Москва (495)268-04-70
 Мурманск (8152)59-64-93
 Набережные Челны (8552)20-53-41
 Нижний Новгород (831)429-08-12
 Новокузнецк (3843)20-46-81
 Ноябрьск (3496)41-32-12
 Новосибирск (383)227-86-73
 Омск (3812)21-46-40
 Орел (4862)44-53-42
 Оренбург (3532)37-68-04
 Пенза (8412)22-31-16
 Петрозаводск (8142)55-98-37
 Пермь (8112)59-10-37
 Пермь (342)205-81-47

Ростов-на-Дону (863)308-18-15
 Рязань (4912)46-61-64
 Самара (846)206-03-16
 Санкт-Петербург (812)309-46-40
 Саратов (845)249-38-78
 Севастополь (8692)22-31-93
 Саранск (8342)22-96-24
 Симферополь (3652)67-13-56
 Смоленск (4812)29-41-54
 Сочи (862)225-72-31
 Ставрополь (8652)20-65-13
 Сургут (3462)77-98-35
 Сыктывкар (8212)25-95-17
 Тамбов (4752)50-40-97
 Тверь (4822)63-31-35

Тольятти (8482)63-91-07
 Томск (3822)98-41-53
 Тула (4872)33-79-87
 Тюмень (3452)66-21-18
 Ульяновск (8422)24-23-59
 Улан-Удэ (3012)59-97-51
 Уфа (347)229-48-12
 Хабаровск (4212)92-98-04
 Чебоксары (8352)28-53-07
 Челябинск (351)202-03-61
 Череповец (8202)49-02-64
 Чита (3022)38-34-83
 Якутск (4112)23-90-97
 Ярославль (4852)69-52-93

Россия +7(495)268-04-70

Казахстан +7(727)345-47-04

Беларусь +(375)257-127-884

Узбекистан +998(71)205-18-59

Киргизия +996(312)96-26-47

<https://scat.nt-rt.ru/> || sqt@nt-rt.ru

Containers Spouts



Fig.	Part No.	Description	Thread	Material	Colour
A	610 499	Flexible spout, with safety vent	S 55	PE-HD	White/Red
B	610 500	Rigid spout, with safety vent	S 55	PE-HD	White/Red
C	610 501	Flexible spout, with safety vent	S 60/61	PE-HD	White/Red
D	610 502	Rigid spout	S 60/61	PE-HD	Blue
E	610 504	Rigid spout, electrostatic conductive , with safety vent	S 60/61	PE-HD-EL	Black
F	610 503	Flexible spout, with safety vent	S 70/71	PE-HD	Black